



Features

- 1. NEMA4/IP67 waterproof and dustproof design, all interfaces with CNLINKO connectors
- 2. Aluminum Alloy enclosure, more resistant to corrosion, shock and vibration
- 3. Adopting EETI solution, resistive touch + industrial-grade, high-performance
- 4. DC 12V power supply (DC24V, 9-36V Optional), support power-on boot, 7x24hours
- 5. High brightness 1000nits sunlight-readable for outdoor application

Specification

Screen	LCD Panel	Panel size	15"
		Resolution	1024*768 4:3
		Brightness (cd/m ²)	1000nits, sunlight-readable
		Contrast ratio	800:1 (Typ.)
		View Angle	80°/80°/80°/65° (R/L/U/D)
	Touch	Touch Type	5 wires Resistive Touch
		Touch Optional	10 points Capacitive Touch
		Surface Hardness	≥3H
		Touch Interface	USB
		Working Life	≥50 million times

Environment	Temperature	Operating: -20 to 70°C, storage: -30 to 70°C
	Humidity	10%~90% @ 30°C, non-condensing

I/O Interfaces	1xHDMI, 1xUSB, 1xDC, 1xVGA
Power Supply	DC12V (DC 24v, 9-36v Optional)

Enclosure	Material	Aluminum Alloy
	Color	Black
	VESA	75mm*75mm/100mm*100mm
	IP grade	FULL IP67 Waterproof
Dimension	Net weight	/
	Gross weight	/
	Product size	378*283*45mm
	Packing size	/

Packaging	1xMonitor, 1xDC Power Cable, 1xAdaptor, 1xUSB Cable, 1xHDMI, 1xVGA
OS	Support Windows 7/8/10, WES, Linux, Ubuntu, Debian, Android, etc.
Mountings	Desk stand holder
	Wall mounting brackets, Embedded mounting screws (optional)
Warranty	1-year free warranty

Sizes Optional

7" 8"	10.1"	12.1"	13.3"	15" 15.6"	17"	19"	21.5"
1024*600 1024*768	1280*800	1024*768 1280*800	1920*1080	1024*768 /1920*1080	1280*1024	1280*1024	1920*1080
4:3	16:10	4:3	16:9	4:3 16:9	4:3	4:3	16:9

Drawing

15-inch

1024*768 4:3

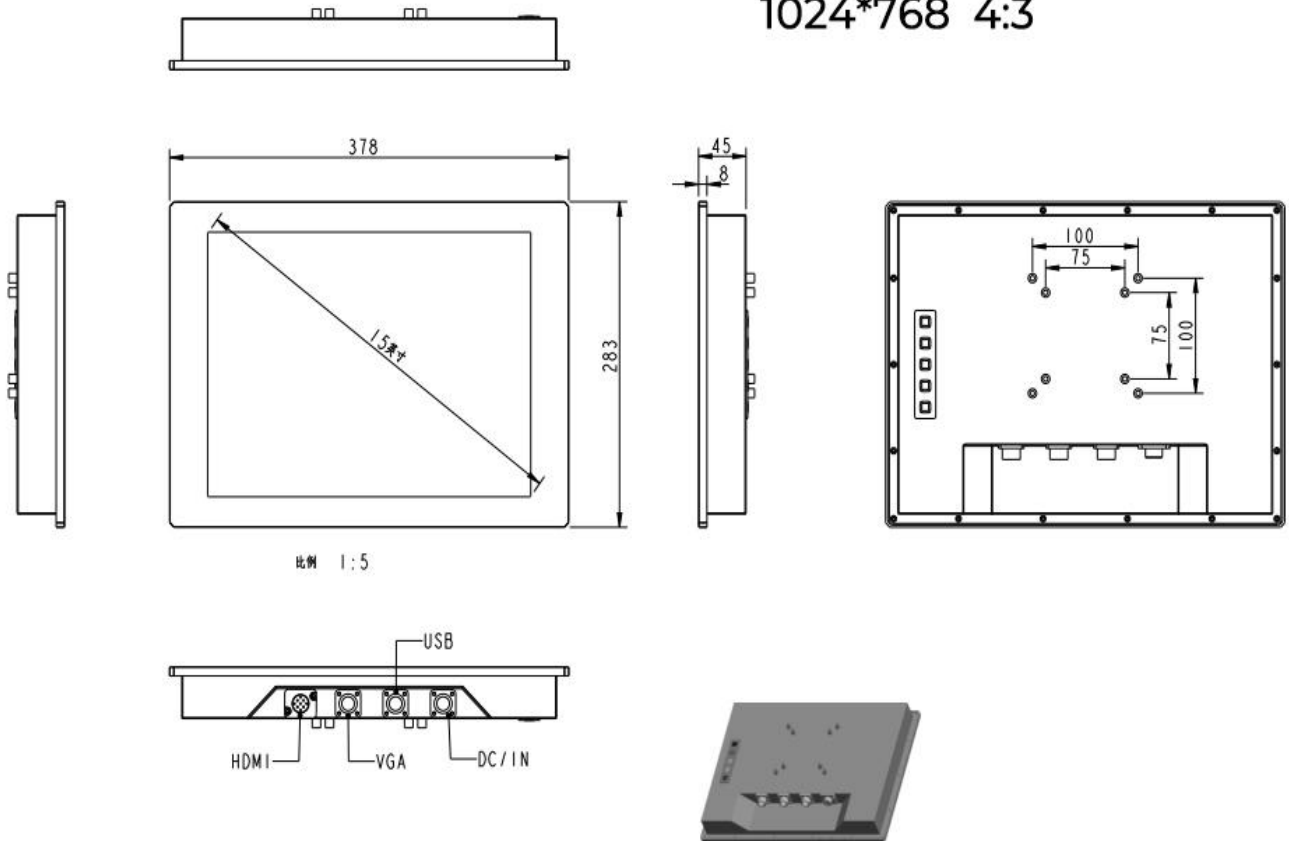

Accessories

- 1x Monitor
- 1x USB
- 1x HDMI
- 1x VGA
- 1x Power cable
- 1x Adaptor